

KENWOOD

CD PLAYER

DP-M7750

INSTRUCTION MANUAL

KENWOOD CORPORATION



B60-1167-00 (JA) (K,E,M,X,Y) (A)
94 / 12 11 10 9 8 7 6 5 4 3 2 1 93 / 12 11 10 9 8 7 6 5 4 3 2

Introduction

Your choice of this product indicates that you are a devotee to excellence in sound reproduction.

We appreciate your patronage and take pride in the long tradition of quality components that our company represents.

So that you can get the most out of your unit, we suggest that you take the time to read through this manual before you hook up and operate your system. This will acquaint you with operating features and system-connection considerations so that your listening pleasure will be enhanced right from the start.

You will notice that in all aspects of planning, engineering, styling, operating convenience and adaptability we have sought to anticipate your needs and desires.

Keep this manual handy for future reference.

For your records

Record the serial number, found on the back of the unit, in the spaces designated on the warranty card, and in the space provided below. Refer to the model and serial numbers whenever you call upon your dealer for information or service on this product.

Model _____ Serial Number _____

Unpacking

Unpack the unit carefully and make sure that all accessories are put aside so they will not be lost.

Examine the unit for any possibility of shipping damage. If your unit is damaged or fails to operate, notify your dealer immediately. If your unit was shipped to you directly, notify the shipping company without delay. Only the consignee (the person or company receiving the unit) can file a claim against the carrier for shipping damage. We recommend that you retain the original carton and packing materials for use should you transport or ship the unit in the future.

The marking of products using lasers (Except for some areas.)

**CLASS 1
LASER PRODUCT**

The label is attached to the rear panel and says that the component uses laser beams that have been classified as Class 1. It means that the unit is utilizing laser beams that are of a weaker class. There is no danger of hazardous radiation outside the unit.

For the U.S.A.

CAUTION:

Use of controls or adjustments or performance of procedures other than those specified herein may result in hazardous radiation exposure.

In compliance with Federal Regulations, following are reproductions of labels on, or inside the product relating to laser product safety.

KENWOOD CORPORATION
SHIONOGI SHIBUYA BUILDING 17-5,
2-CHOME, SHIBUYA, SHIBUYA-KU,
TOKYO, JAPAN

KENWOOD CORP. CERTIFIES THIS EQUIPMENT
CONFORMS TO DHHS REGULATIONS NO.21 CFR
1040.10, CHAPTER I, SUBCHAPTER J.

Location: Back Panel

Accessories

- Audio cord 1
- System control cord 1



- Battery 2
("AAA" or "R03")



- Remote control unit 1



- Magazine 1
(with 6 disc trays)

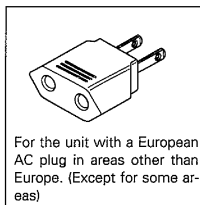
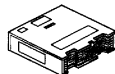

For the unit with a European AC plug in areas other than Europe. (Except for some areas)

Contents

Caution: Read the pages marked carefully to ensure safe operation.

Introduction	2	Repeated playback	18
⚠ Before applying power	3	Random playback	19
⚠ Safety precautions	3	Editing	20
⚠ IMPORTANT SAFEGUARDS	4	Operation of magazine file function	22
Before operation	6	Search of magazine/disc names	26
System connections	8	Recalling of magazine files	28
Controls and indicators	10	Clearing the magazine file	30
Remote control operation	11	Timer operations	31
Before playing CDs	12	In case of difficulty	32
Normal playback	14	Specifications	32
Program playback	16		

Before applying power

Caution: Read this page carefully to ensure safe operation.

For the U.S.A. and Canada

Important!

Units shipped to the U.S.A. and Canada are designed for operation on 120 volts AC only.

CAUTION: TO PREVENT ELECTRIC SHOCK DO NOT USE THE AC PLUG WITH AN EXTENSION CORD, RECEPTACLE OR OTHER OUTLET UNLESS THE BLADES CAN BE FULLY INSERTED TO PREVENT BLADE EXPOSURE.

For the United Kingdom

Important!

Units shipped to the U.K. are designed for operation on 240 volts AC only.

The mains plug must be removed from the wall socket prior to any internal examination.

The wires in this mains lead are coloured in accordance with the following code:

Blue Neutral
Brown Live

The wires in this mains lead must be connected to the terminals in the plug as follows:

Wire colour	Plug terminal marking
Blue	N or Black
Brown	L or Red

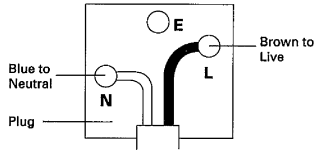

Notes:

1. If a 13-amp plug is used, this must be fitted with a 13-amp fuse.
2. If a 3-pin plug with earthing contact is used, no wire must be connected to the E terminal.

For Australia and Europe

Important!

Units shipped to Australia are designed for operation on 240 V AC only.

Units shipped to Europe are designed for operation on 230 V AC only.

For other countries

Important!

Units shipped to countries other than the above countries are equipped with an AC voltage selector switch on the rear panel. Refer to the following paragraph for the proper setting of this switch.

AC voltage selection

This unit operates on 110 - 120 or 220 - 240 volts AC. The AC voltage selector switch Type A or Type B on the rear panel is set to the voltage that prevails in the area to which the unit is shipped. Before connecting the power cord to your AC outlet, make sure that the setting position of this switch matches your line voltage. If not, it must be set to your voltage in accordance with the following direction.

AC voltage selector switch

Type A

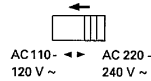

Type B

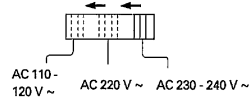

Move switch lever to match your line voltage with a small screwdriver or other pointed tool.

Note:

Our warranty does not cover damage caused by excessive line voltage due to improper setting of the AC voltage selector switch.

Safety precautions

WARNING: TO PREVENT FIRE OR ELECTRIC SHOCK, DO NOT EXPOSE THIS APPLIANCE TO RAIN OR MOISTURE.

	<p>CAUTION RISK OF ELECTRIC SHOCK DO NOT OPEN</p>	<p>CAUTION: TO REDUCE THE RISK OF ELECTRIC SHOCK, DO NOT REMOVE COVER (OR BACK). NO USER-SERVICEABLE PARTS INSIDE, REFER SERVICING TO QUALIFIED SERVICE PERSONNEL.</p>
	<p>THE LIGHTNING FLASH WITH ARROWHEAD SYMBOL, WITHIN AN EQUILATERAL TRIANGLE, IS INTENDED TO ALERT THE USER TO THE PRESENCE OF UNINSULATED "DANGEROUS VOLTAGE" WITHIN THE PRODUCT'S ENCLOSURE THAT MAY BE OF SUFFICIENT MAGNITUDE TO CONSTITUTE A RISK OF ELECTRIC SHOCK TO PERSONS.</p>	
	<p>THE EXCLAMATION POINT WITHIN AN EQUILATERAL TRIANGLE IS INTENDED TO ALERT THE USER TO THE PRESENCE OF IMPORTANT OPERATING AND MAINTENANCE (SERVICING) INSTRUCTIONS IN THE LITERATURE ACCOMPANYING THE APPLIANCE.</p>	

IMPORTANT SAFEGUARDS

 **Caution: Read this page carefully to ensure safe operation.**

Please read all of the safety and operating instructions before operating this unit. For best results, follow all warnings placed on the unit and adhere to the operating and use instructions. These safety and operating instructions should be retained for future reference.

1. Power sources – The unit should be connected to a power supply only of the type described in the operating instructions or as marked on the appliance.

2. Power-cord protection – Power-supply cords should be routed so that they are not likely to be walked on or pinched by items placed upon or against them, pay particular attention to cords at plugs, convenience receptacles, and the point where they exit from the unit.

Never pull or stretch the cord.



3. Grounding or polarization – The precautions should be taken so that the grounding or polarization means of this unit is not defeated.

4. Ventilation – The unit should be situated so that its location or position does not interfere with its proper ventilation.

To maintain good ventilation, do not put records or a table-cloth on the unit. Place the unit at least 10 cm away from the walls.

Do not use the unit on a bed, sofa, rug or similar surface that may block the ventilation openings.

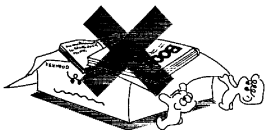

5. Water and moisture – The unit should not be used near water - for example, near a bathtub, washbowl, kitchen sink, laundry tub, in a wet basement, or near a swimming pool, etc.

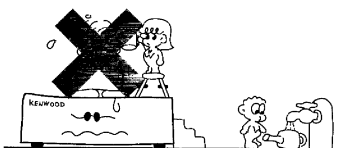

6. Temperature – The unit may not function properly if used at extremely low, or freezing temperatures. The ideal ambient temperature is above +5°C (41°F).

7. Heat – The unit should be situated away from heat sources such as radiators, heat registers, stoves, or other units (including amplifiers) that produce heat.



8. Electric shock – Care should be taken so that objects do not fall and liquid is not spilled into the enclosure through openings. If a metal object, such as a hair pin or a needle, comes into contact with the inside of this unit, a dangerous electric shock may result. For families with children, never permit children to put anything, especially metal, inside this unit.

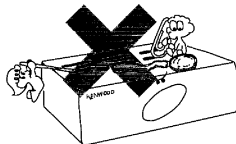

9. Enclosure removal – Never remove the enclosure. If the internal parts are touched accidentally, a serious electric shock might occur.

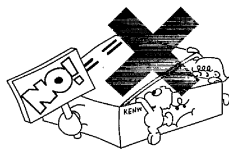

10. Magnetic fields – Keep the unit away from sources of magnetic fields such as TV sets, speaker systems, radios, motorized toys or magnetized objects.

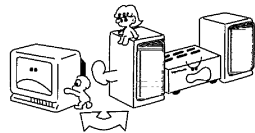

11. Cleaning – Do not use volatile solvents such as alcohol, paint thinner, gasoline, or benzene, etc. to clean the cabinet. Use a clean dry cloth.

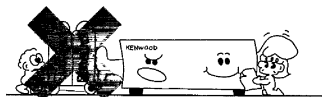

12. Carts and stands – An appliance and cart combination should be moved with care. Quick stops, excessive force, and uneven surfaces may cause the appliance and cart combination to overturn.



13. Nonuse periods – The power cord of the unit should be unplugged from the outlet when left unused for a long period of time.

14. Abnormal smell – If an abnormal smell or smoke is detected, immediately turn the power OFF and pull out the power cord. Contact your dealer or nearest service center.

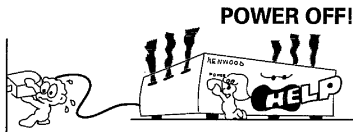

15. Damage requiring service – The unit should be serviced by qualified service personnel when:

- A.** The power-supply cord or the plug has been damaged; or
- B.** Objects have fallen, or liquid has been spilled into the unit; or
- C.** The unit has been exposed to rain; or
- D.** The unit does not appear to operate normally or exhibits a marked change in performance; or
- E.** The unit has been dropped, or the enclosure damaged.

16. Servicing – The user should not attempt to service the unit beyond that described in the operating instructions. All other servicing should be referred to qualified service personnel.

17. Outdoor antenna grounding – If an outside antenna is connected to the receiver, be sure the antenna system is grounded so as to provide some protection against voltage surges and built up static charges. Section 810 of the National Electrical Code, ANSI/NFPA 70, provides information with respect to proper grounding of the mast and supporting structure, grounding of the lead-in wire to an antenna discharge unit, size of grounding conductors, location of antenna-discharge unit, connection to grounding electrodes, and requirements for the grounding electrode. See Figure.

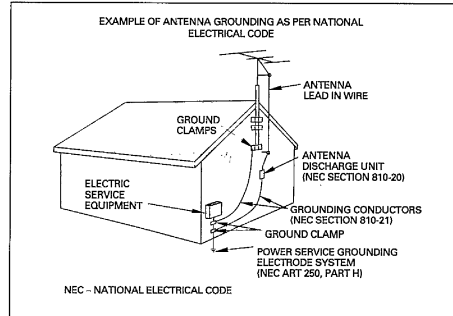

18. Power lines – An outdoor antenna should be located away from power lines.

19. AC outlets – Do not connect other audio equipment with a power consumption larger than that specified to the AC outlet on the rear panel. Never connect other electrical units, such as an iron or toaster, to it to prevent fire or electric shock.

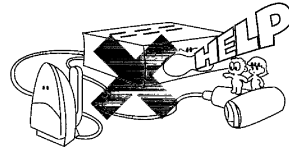

Notes:

1. Item 3 is not required except for grounded or polarized equipment.
2. Item 17 and 18 are not required except for units provided with antenna terminals.
3. Item 17 complies with UL in the U.S.A.

Before operation

Disc handling precautions

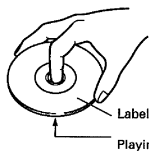

Handling

Hold compact discs so that you do not touch the playing surface.



Do not attach paper or tape to either the playing side or the label side of compact discs.

Caution on disc used



Never play a cracked or warped disc.

During playback, the disc rotates at high speed in the player. Therefore, to avoid danger, never use a cracked or deformed disc or a disc repaired with tape or adhesive agent.

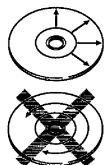

Cleaning

If fingerprints or foreign matter become attached to the disc, lightly wipe the disc with a soft cotton cloth (or similar) from the center of the disc outwards in a radial manner.

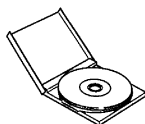

Storage

When a disc is not to be played for a long period of time, remove it from the CD player and store it in its case.

Note related to transportation and movement

Before transporting or moving this unit, carry out the following operations.

1. Turn the power ON but do not load a disc or a magazine.
2. Wait a few seconds and verify that the display shown appears.
3. Turn the power OFF.

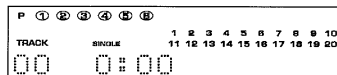

Beware of condensation

When water vapor comes into contact with the surface of cold material, water drops are produced.

If condensation occurs, correct operation may not be possible, or the unit may not function correctly.

This is not a malfunction, however, and the unit should be dried. (To do this, turn the POWER switch ON and leave the unit as it is for several hours.)

Be especially careful in the following conditions:

- When the unit is brought from a cold place to a warm place, and there is a large temperature difference.
- When a heater starts operating.
- When the unit is brought from an air-conditioned place to a place of high temperature with high humidity.
- When there is a large difference between the internal temperature of the unit and the ambient temperature, or in conditions where condensation occurs easily.

Type of disc which can be played with this unit

Disc type	Disc size
CD (general compact disc)	12 cm
CDV (CD with video) audio section	12 cm
CD single	8 cm

The 8 cm CD adaptor on sale cannot be used with this unit. If it is used with this unit, it is possible that the disc or CD player will be damaged.

- If it is required to place CD single discs using a magazine, please purchase and use the optional CDM-608 CD single disc magazine.
- In the case of CDV, the time display and music calendar display are all for the audio section only.

For the U.S.A.

FCC WARNING:

This equipment may generate or use radio frequency energy. Changes or modifications to this equipment may cause harmful interference unless the modifications are expressly approved in the instruction manual. The user could lose the authority to operate this equipment if an unauthorized change or modification is made.

NOTE:

This equipment has been tested and found to comply with the limits for a Class B digital device, pursuant to Part 15 of the FCC Rules. These limits are designed to provide reasonable protection against harmful interference in a residential installation. This equipment may cause harmful interference to radio communications, if it is not installed and used in accordance with the instructions. However, there is no guarantee that interference will not occur in a particular installation. If this equipment does cause harmful interference to radio or television reception, which can be determined by turning the equipment off and on, the user is encouraged to try to correct the interference by one or more of the following measures:

- Reorient or relocate the receiving antenna.
- Increase the separation between the equipment and receiver.
- Connect the equipment into an outlet on a circuit different from that to which the receiver is connected.
- Consult the dealer or an experienced radio/TV technician for help.

Note:

The unit's power supply is secondarily connected. Note following. The unit is not completely disconnected from the mains as long as the power cord is connected to a wall outlet.

Observera:

Apparatens strömförsörjning kopplas från sekundärt. V.g. ge akt på följande. Apparaten frånkopplas inte helt och hållet från strömnätet medan apparatens nätsladd är ansluten till växelströmsuttaget.

Huom:

Virta yksikköön on kytketty pois sekundaaripuolelta. Huomioi seuraava. Tämä yksikkö ei ole kokonaan kytketty pois pää virranjakajasta kun pää katkaisin on liitettyä virtatiiriin.

Bemærk:

Strømmen til apparatet afbrydes på den sekundære side. Vær opmærksom på følgende. Denne enhed er ikke fullstendig koblet fra lysnettet så længe stikket er tilsluttet stikkontakten.

Anmerkning:

Strømmen til apparatet er slått av på sekundærsiden. Vær oppmerksom på det følgende. Dette apparatet koples ikke fullstendig fra nettet så lenge stopselet står i en stikkontakt, selv om strømbryteren settes i av-stilling.

System connections

Make connection as shown below. When connecting the related system components, refer also to the instruction manuals of the related components.
Do not plug in the power lead until all connections are completed.

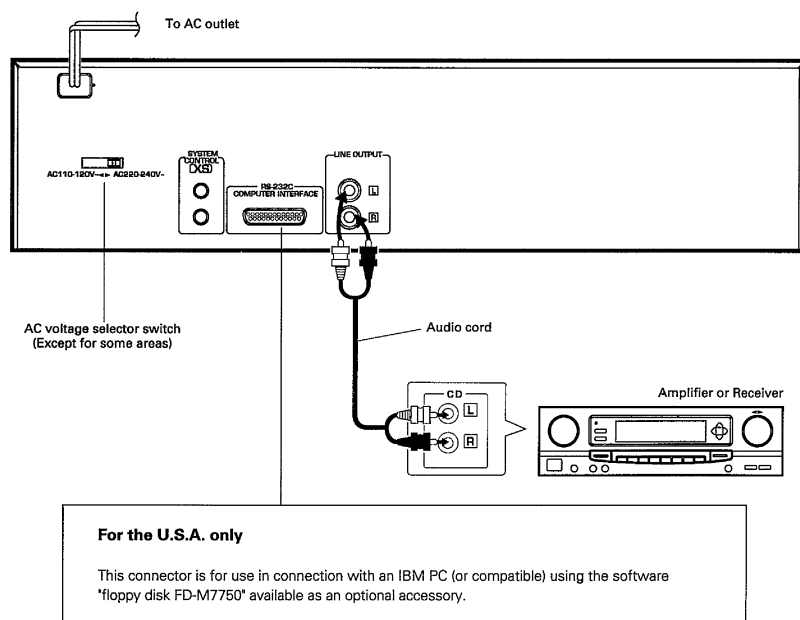

Notes:

1. Connect all cords firmly. If connections are loose, there could be loss of sound or noise produced.
2. When plugging and unplugging connection cords, be sure to first remove the power cord from the AC outlet. Plugging/unplugging connection cords without removal of the power cord can cause malfunctions or damage to the unit.

System control connection

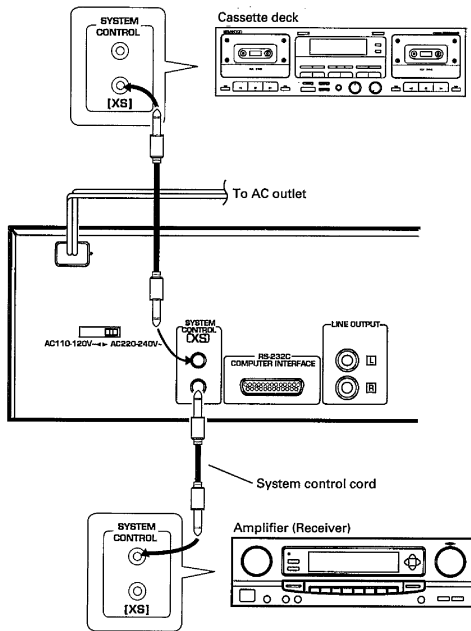

One System control cord is supplied with this unit.

When connecting more than one component for System control operation, use the System control cords provided with the other components.

System control connection

When connected to an amplifier or receiver having KENWOOD SYSTEM CONTROL terminals, system operation such as remote control is made possible. For details, refer to the instruction manual of the amplifier or receiver.

If your amplifier or receiver is not equipped with the SYSTEM CONTROL terminals, do not connect anything to any SYSTEM CONTROL terminal.

Do not connect the unit in any system configuration other than specified.

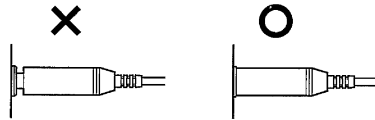

- Be sure to insert the system control cord plugs fully into the SYSTEM CONTROL terminals.
- If the system control cords and audio cords are not connected properly, the automatic system governing remote control and system functions will not operate.

CCRS

By connecting the SYSTEM CONTROL terminal of this unit with the "[XS]" SYSTEM CONTROL terminal of a KENWOOD cassette deck, CCRS recording can be carried out.

The CCRS function is used when recording from a CD to a tape in a cassette deck, and operates to adjust the cassette deck's recording level to the optimum setting according to the playing level of the CD.

For details on the CCRS function, refer to the instruction manual provided with your cassette deck.

PEAK SEARCH

The PEAK SEARCH function detects the section containing the maximum output level on a CD and plays that section repeatedly. This function is to be used when adjusting the recording level manually without using the CCRS recording function of the cassette deck.

- As the PEAK SEARCH function detects the section containing the peak level at a high speed, a section with similar peak level to the section containing the real peak may sometimes be detected in case the recording level of the CD is averaged, for example with a pop music CD.



- ① Select the disc to be recorded.
- ② Press the **PEAK SEARCH** key.
In about 1 minute, the section containing the maximum output level will be played repeatedly.
- ③ Adjust the recording level of the cassette deck.
- ④ To end the repeated playback, press the Stop key **■**.

Controls and indicators

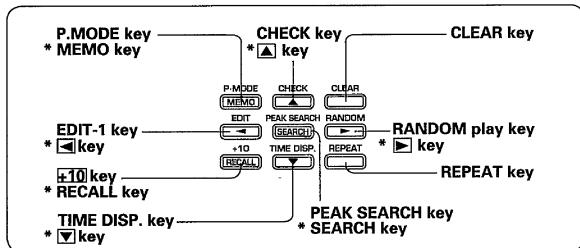
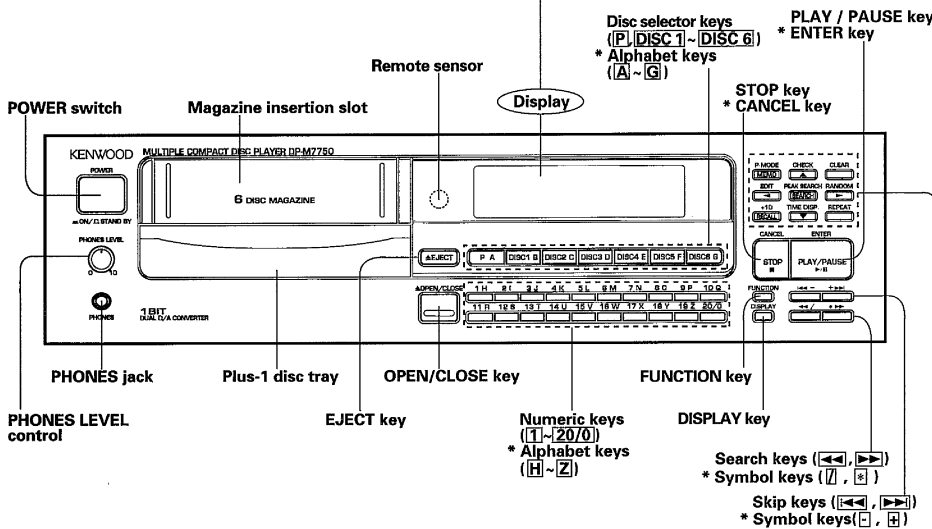
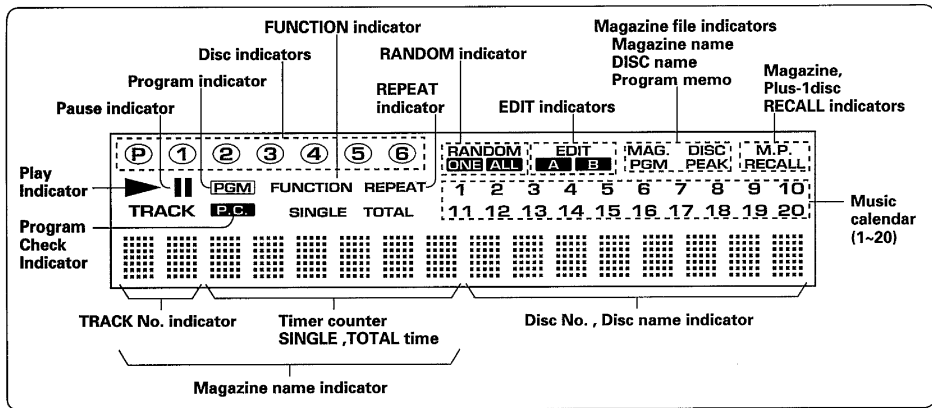

Keys marked * work when the FUNCTION indicator is lighted by pressing the FUNCTION key. These keys are mainly used in registration, searching and recalling operations of the magazine file function (refer to pages 22 to 31).

Remote control operation

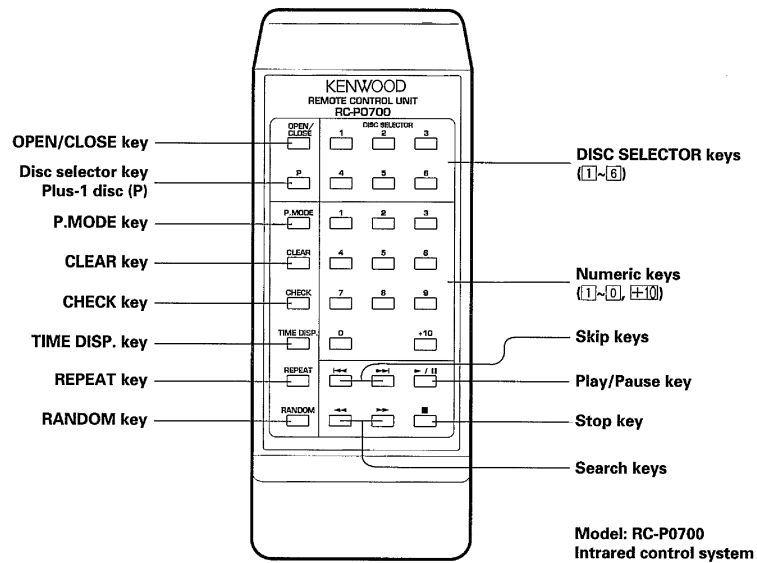

■ Loading batteries

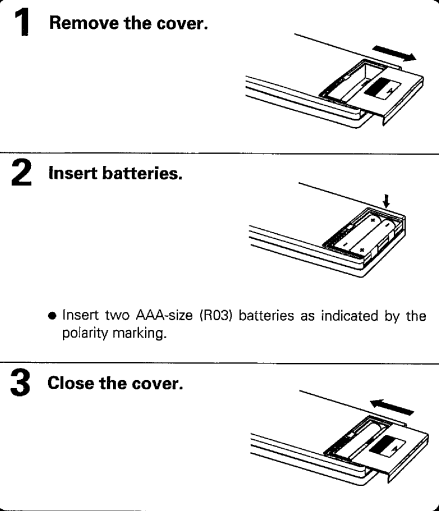

■ Operation procedure

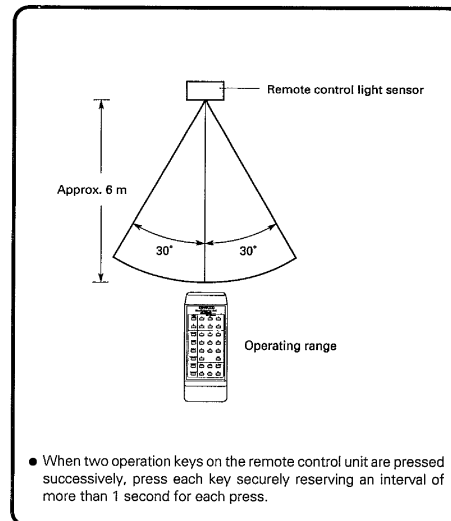

Notes:

1. The supplied batteries are intended for use in operation checks. Therefore, their lives may be shorter than ordinary batteries.
2. When the remote-controllable distance gets shorter than before, replace both batteries with new ones.
3. Malfunction may occur if direct sunlight or the light of a high-frequency lighting fluorescent lamp enters the remote control light sensor. In such a case, change the system installation position to prevent the malfunction.

Before playing CDs

■ Loading a disc into the magazine

1 Pull out the disc tray.

① While pressing in on the lock button

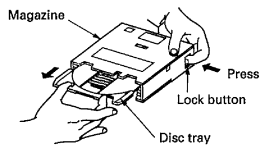

② Pull out the disc tray.

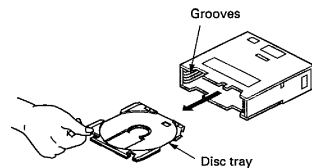

2 Place a disc on the disc tray.

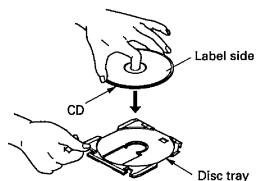

- Commercially-available CD single (8 cm) disc adapters cannot be used in this system. To play CD single (8 cm) discs, use the optional CDM-608 CD single magazine.

3 Insert the disc tray into the magazine.

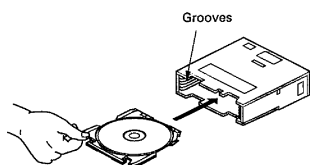

Align the tray with the corresponding left and right grooves and insert horizontally into the magazine.

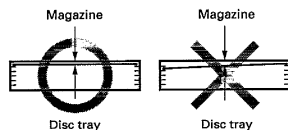

- Be sure to place each disc on a disc tray before inserting into the magazine.
- Even when loading fewer than six discs, make sure there are six disc trays inserted in the magazine during use.
- Always hold the magazine level when carrying.

How to Use Labels

Be sure to put the labels in the designated place. Placement of the label or tape in the wrong place may cause a malfunction.

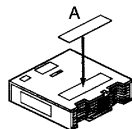

Labeling example:

A: Title of magazine

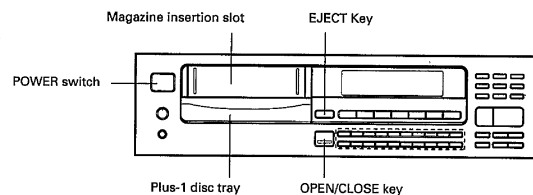

■ Loading a magazine

- 1 Press the POWER key to ON.

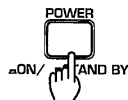

- 2 Insert the magazine.

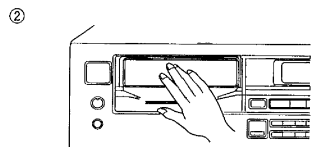
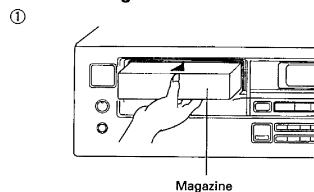

Press in until it locks in place with a click.

■ Removing a magazine

- 1 Press the POWER key to ON.

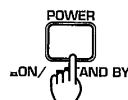

- 2 Remove the magazine.

- 1 Press the eject key.

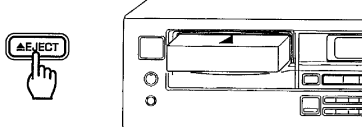

- 2 Pull out the magazine.

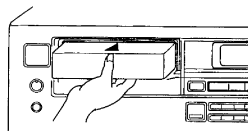

Hold the magazine in the center.

■ Loading a disc in the plus-1 disc tray

- 1 Open the plus-1 disc tray.
- 2 Place a disc on the tray.
- 3 Close the plus-1 disc tray.

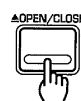
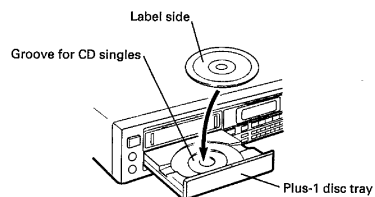

Normal playback

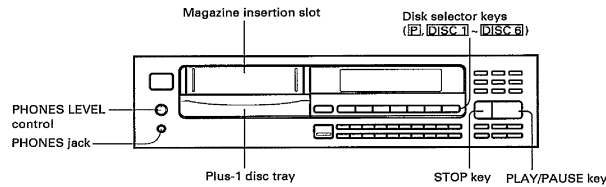

■ Playing a CD from the beginning

1 Place a disc in the magazine or on the plus-1 disc tray.

(Refer to pages 12, 13.)

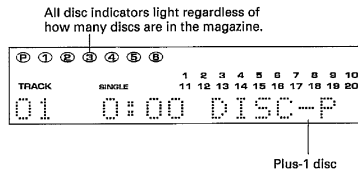

2 Start playback.

Select the desired disc.

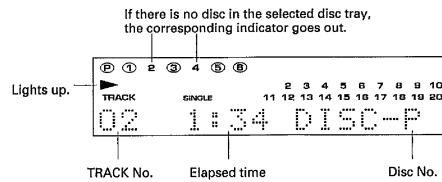

- Playback starts from the selected disc. If two or more discs are loaded, the discs are played in order of their disc numbers.
- If the play [▶/II] key is pressed without selecting a disc, the discs will be played automatically in the following order:
P → 1 → 2 → 3 → 4 → 5 → 6. (P: Plus-1 disc tray)
- To play a single disc only, remove the magazine and place a disc only in the plus-1 disc tray.

To pause playback

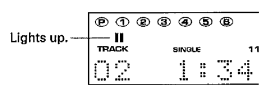

To resume playback, press the [▶/II] key again.

To stop playback



■ Listening through headphones

1 Insert the headphone plug into the headphones jack.

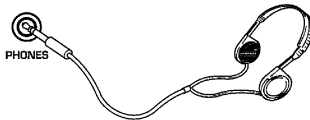

2 Adjust the volume.



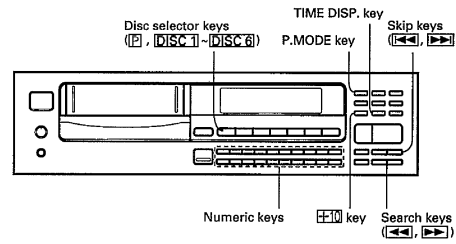

■ Listening from the desired track

1 Make sure the PGM indicator is extinguished.

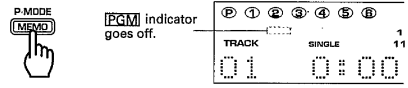

- If the PGM indicator is lighted, press the P.MODE key.

2 Select the desired disc.



3 Select the desired track.

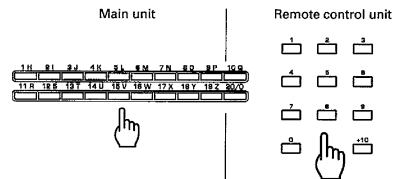

Examples of input

Track No.11: **11**

Track No.20: **20/0**

Track No.30: **+10 +10 +10**
20/0

Examples of input

Track No.11: **+10 1**

Track No.20: **+10 +10 0**

Track No.30: **+10 +10 +10 0**

- Play starts from the selected tune and after.

To skip tracks

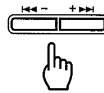

- The tunes are skipped in the direction of the key and the play starts at the beginning of the selected tune.
- When the left arrow key is pressed once during play, the track starts again from the beginning. (If pressed again, the play position returns to the preceding track.)

To fast forward and backward

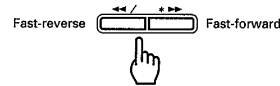

- The track will start to play from where you release the key.

TIME DISP. key

Press the TIME DISP key when you want to check the elapsed time and remaining time of the track being played. Every time the TIME DISP key is pressed, the displayed time changes as shown below. (However, only the SINGLE TIME can be displayed during random playback.)

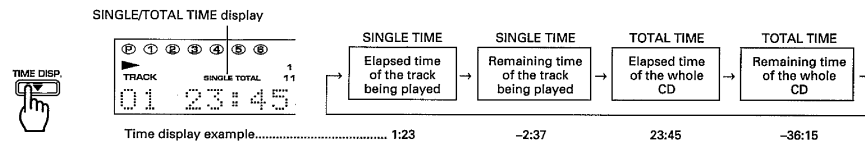

Program playback

The program mode allows you to play desired tracks of 7 discs in the order you want to listen to. A maximum of 32 selections can be entered in memory.

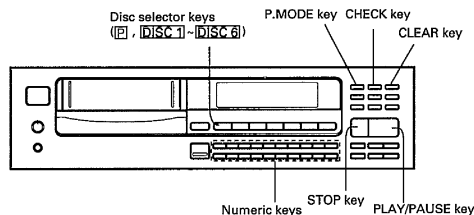

■ Playing desired tracks in desired order (PGM mode)

1 Enter the PGM mode.

Press the **P.MODE** key.

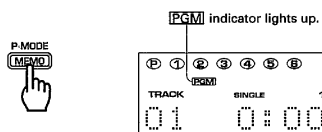

2 Program desired tracks in desired order.

Example

To select track no.5 on disc 4:

① Select the disc.

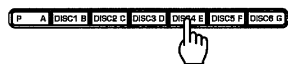

② Select the track.

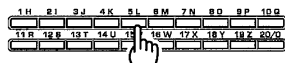

- Repeat steps ① and ② to program up to 32 tracks. After 33 or more tracks are selected, "FULL" is displayed.

To program all tracks on a disc:

Omit step 2-②.

- If more than eight seconds elapse before proceeding to step 2-②, all tracks on the selected disc will be programmed.

If you make a mistake during entry:

Press the **CLEAR** key and re-enter the correct number.

3 Start playback.



- Tracks are played in the order they are programmed (P-No.).
- If one of the skip keys (▶▶ or ◀◀) is pressed during programmed playback, the track being played is skipped in the forward or reverse direction.

To check the programmed order

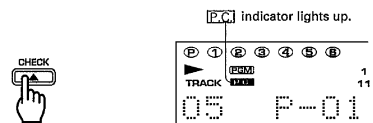

- Every time the **CHECK** key is pressed, the track No., DISC No. and the order it was programmed (P-No.) are displayed in the order of programming.
- The previous display will resume in a few seconds.

To resume normal playback

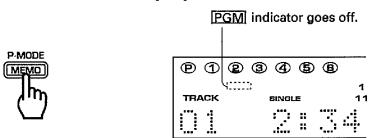

- The playback in the order of the track Nos. on CD will start after the track being played.

To stop programmed playback



Note:

If the magazine does not contain a disc corresponding to the disc No. selected in step 2-①, the disc and track are programmed but canceled at the time of playback.

■ To add a track to the program

Select the track No. to be added.

- ① Select the disc.



- ② Select the track number.

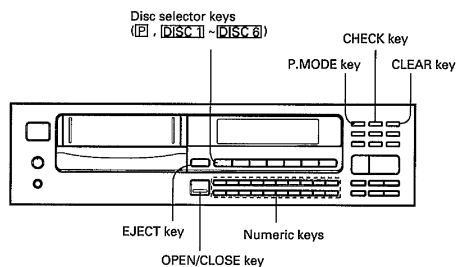
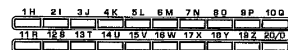

■ To change a track in the program

- 1 Press the CHECK key.

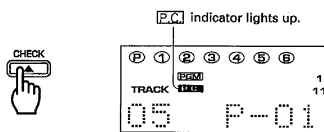

Press until the P-No. to be changed is displayed.

- 2 Select the track No. to replace the previous one.

- ① Select the disc.

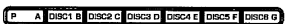

- ② Select the track number.

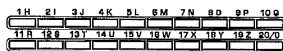

Press while the [CHECK] indicator is lighted.

- The track being played cannot be changed.

■ To clear tracks from the program

Clearing from the last track



- Every time the key is pressed, tracks are cleared from the last track in order.
- The currently playing track cannot be deleted.

Clearing the whole of program

Press any one of these keys.



Auto-Space function

In the program mode, a space of about 4 seconds is inserted automatically between the programmed tracks. This function is provided to facilitate the DPSS function of the cassette deck. However, such a space may also be inserted in case the sound of two tracks are continued, for example with some classic music and live recordings.

Repeated playback

■ Repeated playback

Repeated playback of programmed tracks

1 Enter the PGM mode.

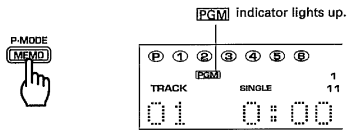

2 Select the desired track(s).

(Refer to page 16.)

① Select the desired disc.



② Select the desired tracks.

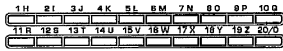

- When you want to repeat only one track, go to step 3 below.
- Repeat steps ① and ② to program up to 32 tracks.

3 Press the REPEAT key.

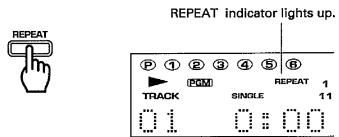

4 Start playback.



- All of the selected tracks will be played repeatedly.
- If only one track is selected, that track will be played repeatedly.

Repeated playback of the whole CDs

1 Make sure the PGM indicator is extinguished.

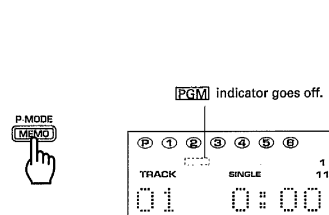

- If the PGM indicator is lighted, press the P.MODE key.

2 Press the REPEAT key.

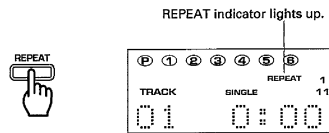

3 Start playback.



- All tracks on all discs in the magazine and Plus 1 tray will be played repeatedly.

To resume normal playback

Press the REPEAT key again.

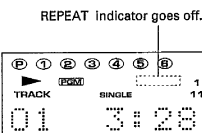

- The playback will be resumed under the CD player mode set before the repeat.

Random playback

This function allows for random selection of the tracks each time and continuous playing in any order.

■ Playing tracks in a random order

1 Make sure the PGM indicator is extinguished.

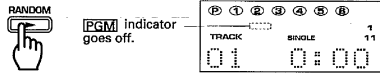

- If the **PGM** indicator is lighted, press **P.MODE** key.

2 Select the desired random mode.

To randomly play a single disc

① Select the disc.



To randomly play all discs

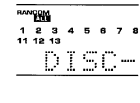
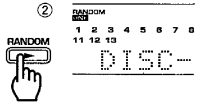

Select RANDOM **ONE**.

Select RANDOM **ALL**.

Each press changes the random mode as shown below.

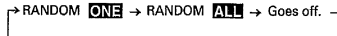

- Tracks on one disc are selected in a random order and played.

- Tunes are selected and played at random from all of the discs.

Display when track 7 of disc 3 is selected first



- When one tune ends, the next tune is randomly selected and played.

Display when track 3 of disc 5 is selected next



- Random play stops after all of the tunes have been played once.
- If the **REPEAT** key is pressed, random play operation is repeated continuously.

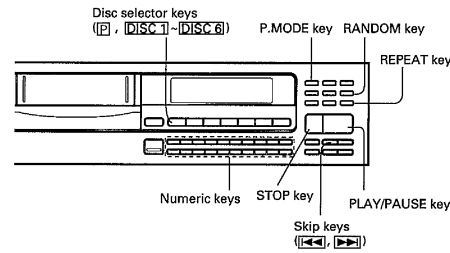

To select another track during random play

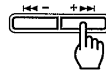

- When the **←** key is pressed once during random play, the track starts again from the beginning.

To cancel random play

Press to off.

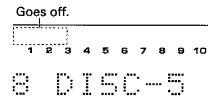

Each press changes the random mode as shown below.

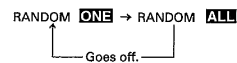

- Normal play starts from the track being played.

or



- Playback stops.

Editing

When recording tunes from one or more CDs onto a tape, this function edits the tunes to ensure that the tunes fit within the specified tape length and that the last tune on either side does not get cut off in the middle.

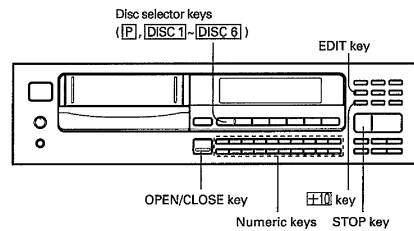

■ To edit a disc

1 Press the STOP key.

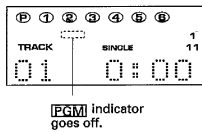

- Make sure the PGM indicator is extinguished.

2 Press the EDIT key.

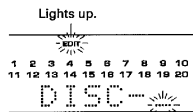

3 Select the disc you want to edit.



Select one disc.

- Editing using two or more discs at one time is not possible.

4 Enter the tape length.

Example
For C-46: +10 +10 +10 +10 6
For C-30: +10 +10 +10 20/0

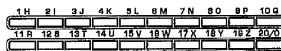

Editing is carried out as follows.

- (1) The specified tape length is divided in half, then as many tunes as will fit in the A file (side A of the tape) are selected starting with the small track numbers.

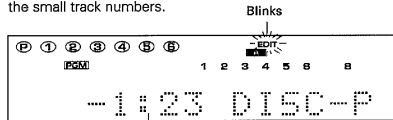

Remaining time in file A

- (2) After a few seconds the remaining time left in the A file appears on the display, then the B file (side B of the tape) is edited in the same manner.

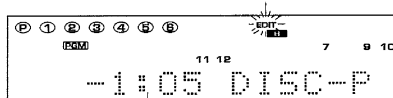

Remaining time in file B

- If you press the STOP key or OPEN/CLOSE key while editing is being carried out, editing is interrupted and stops.

Editing completed

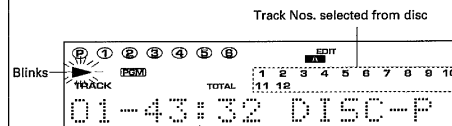

Total time of selected tracks

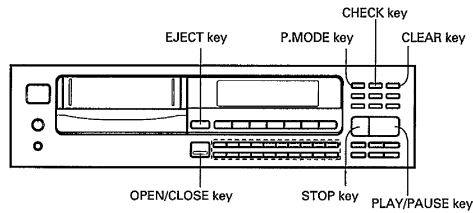

■ To check the edited program contents

Press the CHECK key.

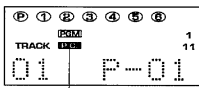

Ⓜ indicator lights up.

- Every time the CHECK key is pressed, the track Nos. are displayed in the edited order.

■ To record an edited program

The CCRS recording function may be used by connecting the CD player to any KENWOOD cassette deck with an "X" mark, using a system control cord. For details please refer to "Recording of CD playback" section in your cassette deck instruction manual.

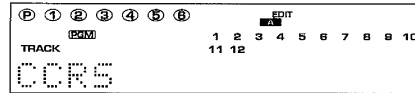

CCRS display

■ To play an edited program

① To play the A file:



The tunes in the A file are played in sequence and the player enters pause mode at the beginning of the B file.

② To play the B file:



- Playback stops after having played the B file.

■ To erase the edited contents

Press any one of these keys.

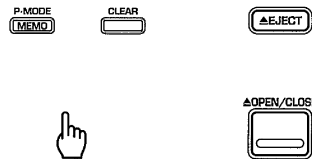

- The whole of the edited contents are cleared.

Notes:

1. While you can edit with a different time setting to that of the tape you are using, part of the tape may be left with nothing recorded on it, or the last track on side A or side B may be cut short.
2. Up to a maximum of 32 tracks can be edited using this function.
3. The EDIT function may not operate properly for discs having only one track or having tracks of long duration such as classical music.

Operation of magazine file function

This function allows magazines or discs to be named or to store programs and recall them when playing discs. (Names and programs of up to 42 magazines and disc names of up to 255 CDs can be registered.)

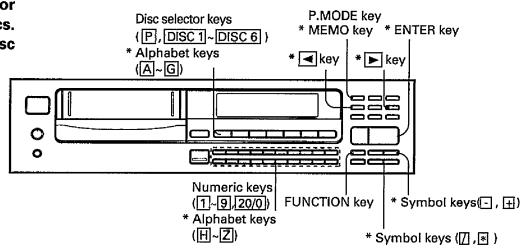

Magazine name registration

The title or genre names given to magazines can be registered with up to 8 characters per name. Preparation: Insert the magazine to be registered, and proceed to the following procedures while the unit is in the stop mode.

1 Press the FUNCTION key.

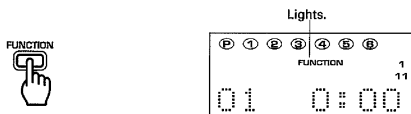

2 Select the magazine name mode.

① Select MAG.



Each press changes the mode.

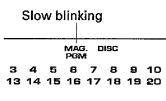

② Establish the selection.

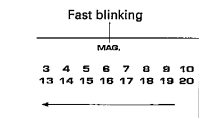

"DISC 1 IS LOADING" is displayed.
↑
1-6

In about 1 minute, "PLEASE ENTER MAGAZINE NAME" is displayed.

3 Enter the magazine name.

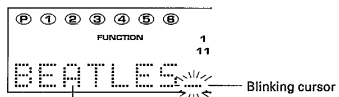
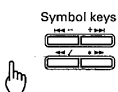
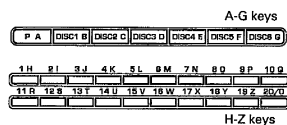

Example when "BEATLES" is entered as the magazine name.

- Up to 8 characters can be entered.
- If you make a mistake, move the cursor back with the left arrow key and correct the entry.
- Press the right arrow key to enter a space.
- To enter a numeral, press the FUNCTION key to switch the key operation (display) mode.

Usable numeric keys
{ 1 | to | 9 | .20/0 }

4 Save the registration.

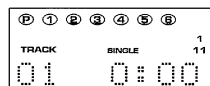

Returns to previous display.

- To recall the magazine name registered here, refer to the procedure on page 28.

■ Disc name registration

The titles given to discs can be registered with up to 8 characters per name.

Preparation: Place the disc to be registered in the magazine or Plus-1 disc tray, and proceed to the following procedures while the unit is in the stop mode.

1 Press the FUNCTION key.

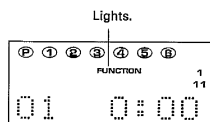

2 Select the disc name mode.

① Select DISC.



Each press changes the mode.

Slow blinking

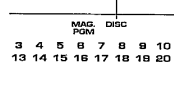

② Establish the selection.

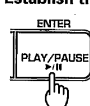

Fast blinking

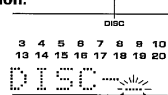

- In a few seconds, "PLEASE SELECT DISC" will be displayed.

3 Select the disc.

① Select the disc to be named.



② Establish the selection.



- If the selected disc No. does not contain a disc, "NO DISC" is displayed. Select another disc.

In about 20 seconds, "PLEASE ENTER DISC NAME" will be displayed.

4 Enter the disc name.



A-G keys

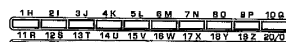

H-Z keys

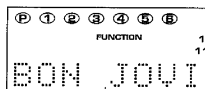

Example when "BON JOVI" is entered as the disc name.

- Up to 8 characters can be entered.
- If you make a mistake, move the cursor back with the ◀ key and correct the entry.
- Press the ▶ key to enter a space.
- To enter a numeral, press the [FUNCTION] key to switch the key operation (display) mode.

Usable numeric keys
(1 to 9, 20/0)

5 Save the registration.

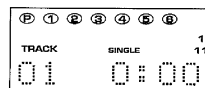

Returns to previous display.

- To register the name of another disc, start from step 1 again.
- To recall the disc name registered here, refer to the procedure on page 28 or 29.

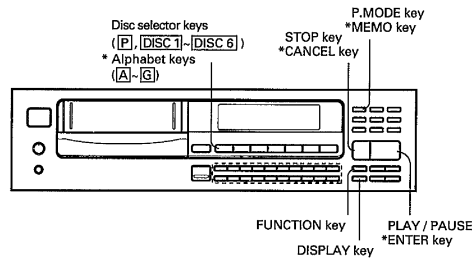

■ Program memo registration

The contents of the program of discs in each magazine can be registered and recalled when playing it.

Preparation: Place the magazine to be registered, and proceed to the following procedures while the unit is in the stop mode.

1 Program desired tracks.

(Refer to page 16.)

• The CD in the Plus-1 disc tray cannot be used in program memo registration.



2 Press the FUNCTION key.

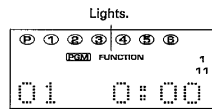

3 Select the program memo mode.

① Select PGM.

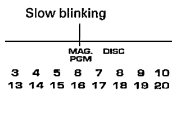

② Establish the selection.

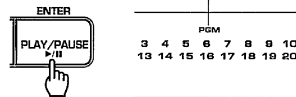

Each press changes the mode.

In about 1 minute, "PLEASE ENTER TO SAVE PROGRAM" will be displayed.

4 Save the registration.

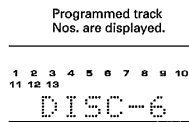

- Display content
 - ① When the program has been registered, "PROGRAM MEMO IS SET" is displayed.
 - ② If the program contains tracks on the CD on the Plus-1 disc tray, "CANNOT SAVE PROGRAM" is displayed.
 - ③ If tracks have not been programmed, "NO PROGRAM IS ENTERED" is displayed.
- If ② or ③ is displayed, restart from the beginning.
- To recall the program memo registered here, refer to the procedure on page 28.

DISPLAY key

The following items are displayed only when the magazine or disc name is registered or recalled (refer to pages 22 to 29).



Each press changes the mode.

When a magazine name is recalled:

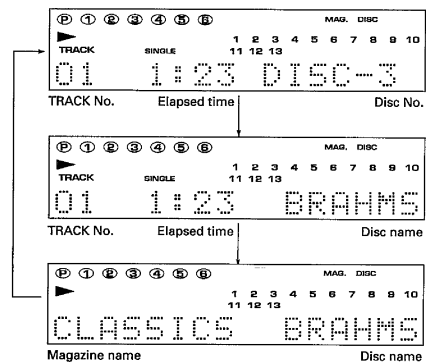

When disc name is registered or a disc on the Plus-1 tray is recalled:

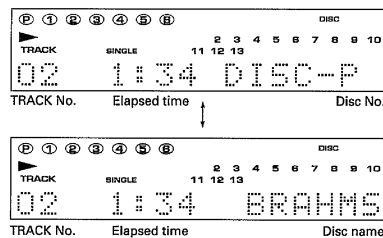

When a magazine name is registered:

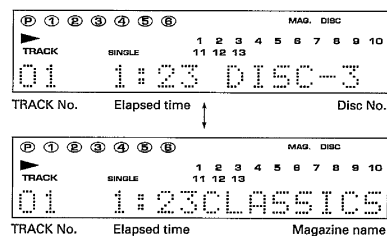

- When no magazine or disc name has been registered, the display does not change even when the key is pressed.

Notes:

1. As the magazine file function reads and records the TOC data (information on number of tracks and playing time), search and recalling cannot be performed properly if the discs in the magazine are changed, added or removed.
2. The magazine names, disc names and program memos registered with the magazine file function may be cleared if the power of the unit has been OFF for a long period of time.
3. If the display disappears or a wrong display appears during operation of the magazine file function, perform the procedure "To clear all memo (memory)" on page 30.
4. The magazine file function cannot be used after editing.

Search of magazine/disc names

The names registered for a magazine or discs can be searched in the alphabetical order or using the initial letter of them.

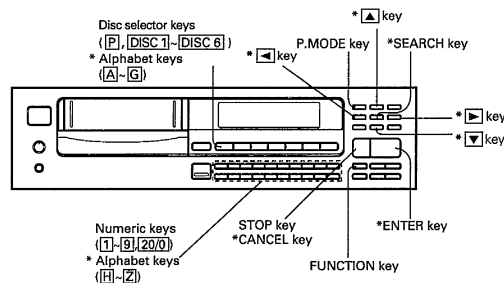

To search for a magazine name

Preparation: Insert a desired magazine and proceed to the following while the unit is in the stop mode.

1 Press the FUNCTION key.

2 Select the magazine search mode.

① **Select MAG.** (Slow blinking)

Each press changes the mode.

② **Establish the selection.** (Fast blinking)

3 Search for the magazine name. (In case more than one name has been registered)

Searching in alphabetical order:

Press the ∇ or \blacktriangle key.

(Incrementing order) (Decrementing order)

Searching with initial letter of name:

Enter the initial letter of the magazine name to search for.

- The search can also be initiated with the numeric or symbol keys.
- If there is no magazine name starting with the entered initial letter, the magazine name starting with the next letter in alphabetical order is displayed.

• If only one magazine name has been registered, the display is not changed by pressing any key.

To display the names of discs in the magazine:

① **Change the key operation (display) mode.**

FUNCTION disappears.

② **Select the disc to be displayed.**

To end (abort) search:

■ To search for a disc name

Preparation: Insert a desired magazine and proceed to the following while the unit is in the stop mode.

1 Press the FUNCTION key.

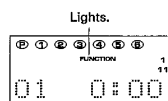

2 Select the disc search mode.

① Select DISC.



MAG. ↔ DISC

Each press alternates the modes.

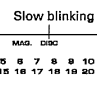

② Establish the selection.

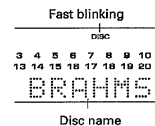

3 Search for the disc name. (In case more than one name has been registered)

Searching in alphabetical order:

Press the ▼ or ▲ key.



(Incrementing order)



(Decrementing order)

ABC...XYZ * +/- 1 2 3

Searching with initial letter of name:

Enter the initial letter of the disc name to search for.

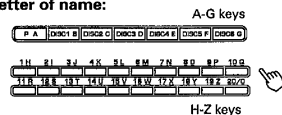

- The search can also be initiated with the numeric or symbol keys.
- If there is no disc name starting with the entered initial letter, the disc name starting with the next letter in alphabetical order is displayed.

- If only one disc name has been registered, the display is not changed by pressing any key.

To display the name of the magazine containing the disc:

Press the ◀ or ▶ key.

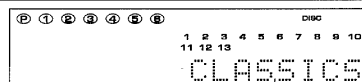

The disc name and magazine name are switched alternately every time the key is pressed.

To end (abort) search:



Recalling of magazine files

The registered magazine names, disc names, program memos, etc. can be recalled with the following procedures.

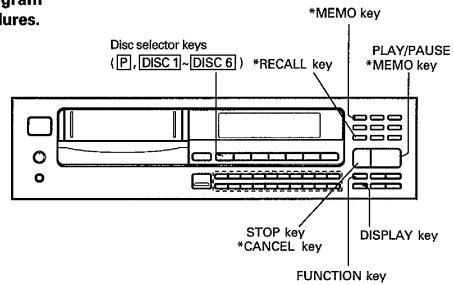

■ Recalling the magazine file

Preparation: Insert the desired magazine and proceed to the following while the unit is in the stop mode.

1 Press the FUNCTION key.

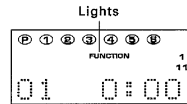

2 Select the magazine recall mode.

① Select M.RECALL.



M. ← P.
RECALL RECALL

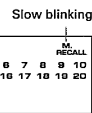

Each press alternates the modes.

② Establish the selection.

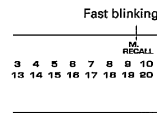

- When the magazine data is recalled in about 1 minute, "MAGAZINE IS *****" is displayed.
Registered magazine name
- If there is no data for the magazine, "MAGAZINE IS NOT SET" is displayed.
- If a program memo has been registered for the magazine, the unit enters the PGM (program) mode and the program is recalled.

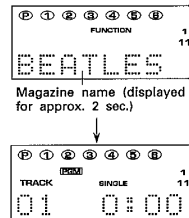

To display the names of discs in the magazine:

When the magazine name is recalled:

① Select the disc to be displayed.



② Press the DISPLAY key.

Example when the key is pressed twice

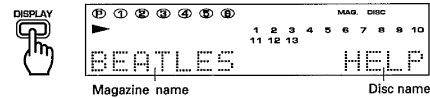

When the program memo is recalled:

① Play the program.



② Press the DISPLAY key.

Example when the key is pressed twice

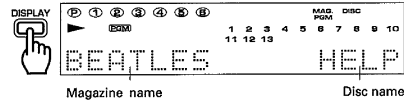

■ Recalling the disc name (Plus-1 disc)

Preparation: Insert a disc in the Plus-1 tray and proceed to the following while the unit is in the stop mode.

1 Press the FUNCTION key.

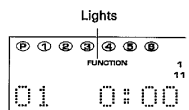

2 Select the Plus-1 disc recall mode.

① Select P.RECALL.



M. ↔ P.
RECALL RECALL

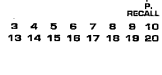

Each press alternates the modes.

② Establish the selection.

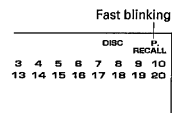

- When the disc data is recalled in about 1 minute, "DISC P IS *****" is displayed.
Registered disc name
- If there is no data for the disc, "DISC P IS NOT SET" is displayed.
- If there is no disc in the Plus-1 tray, "NO DISC" is displayed.

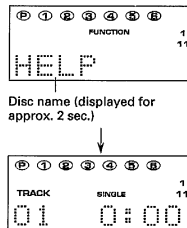

Clearing the magazine file

The names given to magazines and discs and the program memos can be cleared either individually or all together.

■ To clear a magazine or disc name

Preparation: Insert a desired magazine and proceed to the following while the unit is in the stop mode.

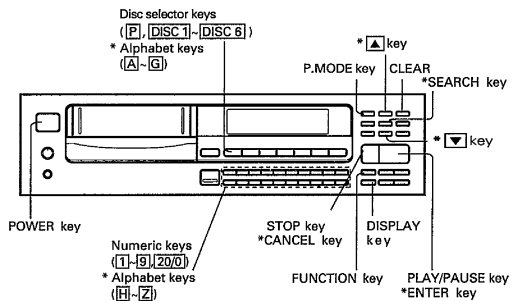

1 Press the FUNCTION key.

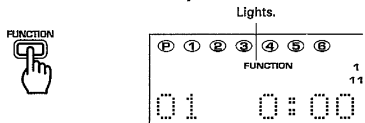

2 Select the magazine mode or disc mode according to the name you want to clear.

① Select MAG. or DISC.

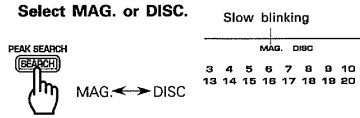

Each press alternates the modes.

② Establish the selection.

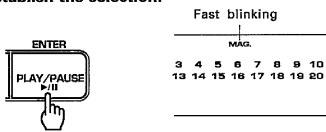

3 Search the name to be cleared.

Searching in alphabetical order:

Press the ∇ or \blacktriangle key.

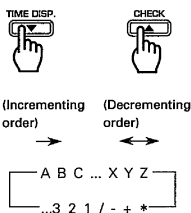

Searching from initial letter of name:

Enter the initial letter of the name to be searched.



• The search can also be initiated with the numeric or symbol keys.

• If there is no name starting with the entered initial letter, the name starting with the next letter in the alphabetical order is displayed.

4 Press the CLEAR key.

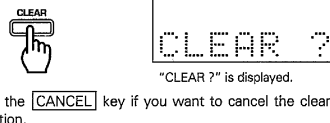

• Press the CANCEL key if you want to cancel the clear operation.

5 Press the ENTER key.

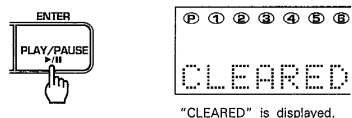

"CLEARED" is displayed.

6 End the clear operation.



• To clear the name of another magazine or disc, start from step 1 again.

■ To clear all memo (memory)

All of the magazine names, disc names and program memos can be cleared simultaneously at once.

Preparation: Proceed to the following while the unit is in the stop mode.

1 Turn power OFF.

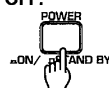





2 While pressing and holding the CLEAR key, press the POWER switch to turn power ON.

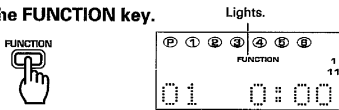
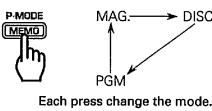

• "ALL MEMOS ARE CLEARED" is displayed.

■ To clear a program memo

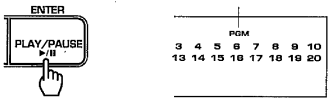
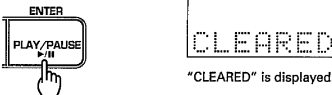
Preparation: Insert the magazine whose program is to be erased, recall the magazine file, then perform the following operations. (Refer to page 28.)

<p>1 Press the FUNCTION key.</p> 	<p>In about 1 minute, "PRESS ENTER TO SAVE PROGRAM" will be displayed.</p>
<p>2 Select the program mode.</p> <p>① Select PGM.</p>  <p>Each press change the mode.</p>	<p>3 Press the CLEAR key.</p>  <p>"CLEAR ?" is displayed.</p>
<p>② Establish the selection.</p> 	<p>4 Press the ENTER key.</p>  <p>"CLEARED" is displayed.</p>
<p>5 End the clear operation.</p> 	

Timer operations

This unit incorporates a built-in timer standby function. By using an audio timer optionally available in the market, wake-up playback can be started at any time of the day.

Preparations for timer playback

Connect the power cords of the components to the timer so that their powers can be turned on via the timer.

Read carefully the instruction manual of your audio timer.

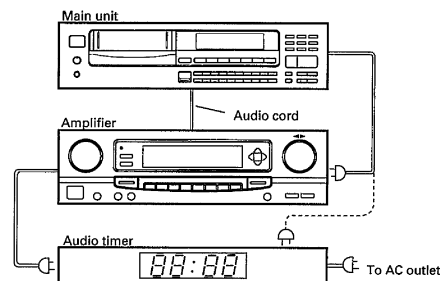

■ Timer playback

1 Set the power switches of the components to ON.

2 Place a disc in the magazine or on the plus-1 disc tray.
(Refer to page 13.)

3 Set the amplifier volume.

- ① Start playback.
- ② Adjust the volume of the amplifier.
- ③ Stop playback.

4 Set the timer at the desired time of the day.

- Read carefully the instruction manual of your audio timer.
- When the set time comes, playback starts automatically.

When operating the unit other than CD player using an audio timer, be sure to remove the disc or the magazine from the CD player.

